

L:

CBL-HFPD203MB-1m	1000mm±20mm
CBL-HFPD203MB-2m	2000mm±20mm
CBL-HFPD203MB-3m	3000mm±30mm
CBL-HFPD203MB-4m	4000mm±30mm
CBL-HFPD203MB-5m	5000mm±50mm
CBL-HFPD203MB-6m	6000mm±50mm
CBL-HFPD203MB-7m	7000mm±50mm
CBL-HFPD203MB-8m	8000mm±50mm
CBL-HFPD203MB-9m	9000mm±50mm
CBL-HFPD203MB-10m	10000mm±50mm

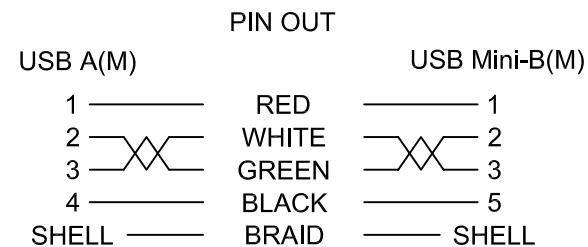

No	MATERIALS LIST:
1.	CABLE:UL2725 (26AWG*1PR+D+AM)x2C+24AWG*2C+AM+B OD:5.4mm PVC JACKET COLOR:BLACK
2.	CONNECTOR:USB 2.0 A/M, 4P, WHITE INSULATOR SOLDER TYPE, NICKEL PLATED SHELL
3.	CONNECTOR:USB 2.0 Mini-B/M, 5P, BLACK INSULATOR SOLDER TYPE, NICKEL PLATED SHELL
4.	PVC MOLDED HOUSING, BLACK COLOR

Jargy part no.	Client part no.	Approved	SCALE	UNIT
CBL-HFPD203MB-Xm			1 : 1	mm
Drawing Name		Drawn	Date	REV.
USB 2.0 A to Mini-B Cable M/M		<i>Kevin Hsu</i>	2015/09/04	1.0

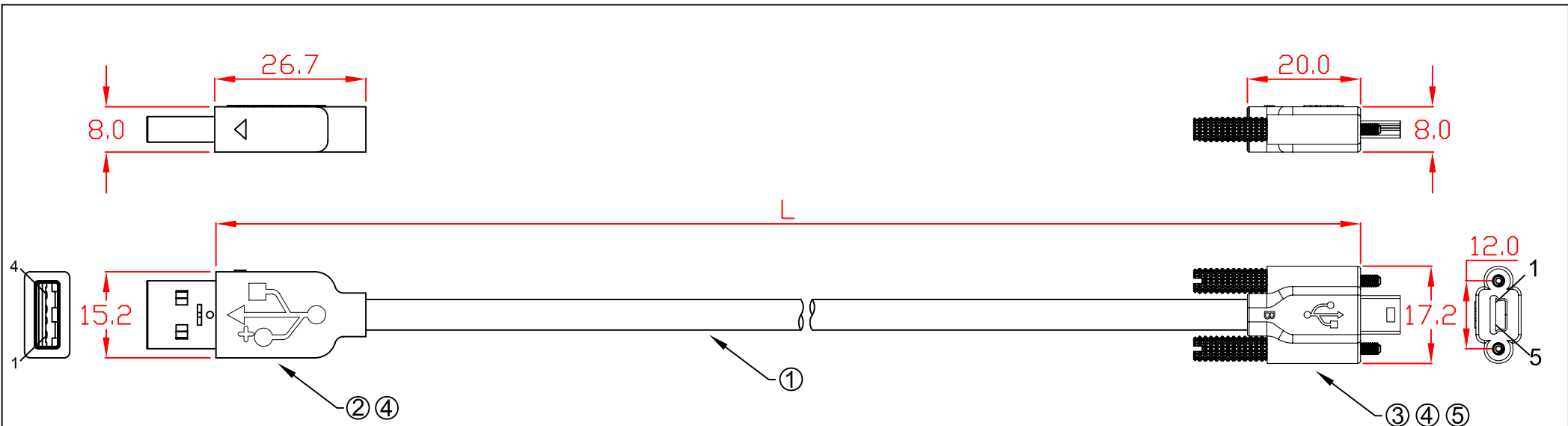

L:

CBL-HFPD203MBS-1m	1000mm±20mm
CBL-HFPD203MBS-2m	2000mm±20mm
CBL-HFPD203MBS-3m	3000mm±30mm
CBL-HFPD203MBS-4m	4000mm±30mm
CBL-HFPD203MBS-5m	5000mm±50mm
CBL-HFPD203MBS-6m	6000mm±50mm
CBL-HFPD203MBS-7m	7000mm±50mm
CBL-HFPD203MBS-8m	8000mm±50mm
CBL-HFPD203MBS-9m	9000mm±50mm
CBL-HFPD203MBS-10m	10000mm±50mm

No	MATERIALS LIST:
1.	CABLE:UL2725 (26AWG*1PR+D+AM)x2C+24AWG*2C+AM+B OD:5.4mm PVC JACKET COLOR:BLACK
2.	CONNECTOR:USB 2.0 A/M, 4P, WHITE INSULATOR SOLDER TYPE, NICKEL PLATED SHELL
3.	CONNECTOR:USB 2.0 Mini-B/M, 5P, BLACK INSULATOR SOLDER TYPE, NICKEL PLATED SHELL
4.	PVC MOLDED HOUSING, BLACK COLOR
5.	SCREW:#4x33 M2

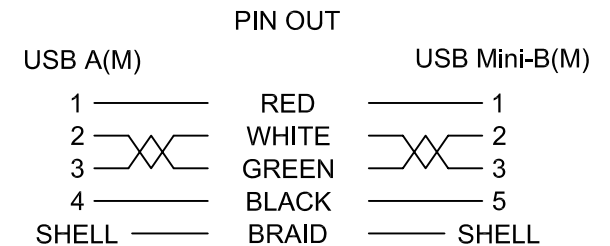

Jargy part no.	Client part no.	Approved	SCALE	UNIT
CBL-HFPD203MBS-Xm			1 : 1	mm
Drawing Name		Drawn	Date	REV.
3m USB 2.0 A to Mini-B Cable M/M		<i>Kevin Hsu</i>	2015/09/04	1.0

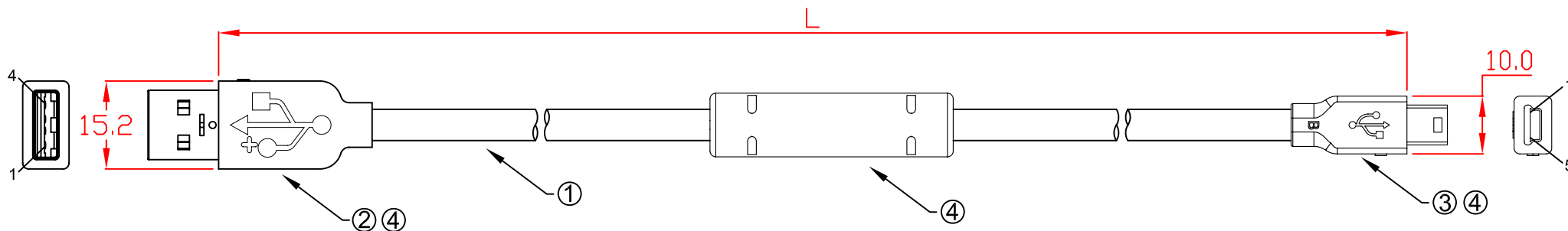
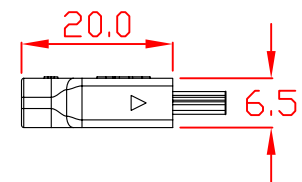
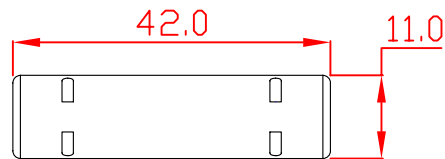
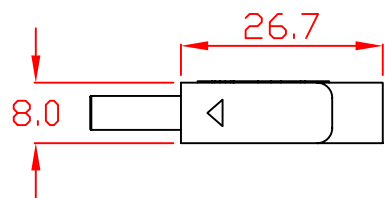

L:
 CBL-HFD203MB-15m 15000mm±50mm
 CBL-HFD203MB-20m 20000mm±50mm

USB A(M)		PIN OUT	USB Mini-B(M)	
1	—	RED	1	—
2	⋈	WHITE	2	⋈
3	⋈	GREEN	3	⋈
4	—	BLACK	5	—
SHELL	—	BRAID	SHELL	—

No	MATERIALS LIST:
1.	CABLE:UL2725 (26AWG*1PR+D+AM)x2C+24AWG*2C+AM+B OD:5.4mm PVC JACKET COLOR:BLACK
2.	CONNECTOR:USB 2.0 A/M, 4P, WHITE INSULATOR SOLDER TYPE, NICKEL PLATED SHELL
3.	CONNECTOR:USB 2.0 Mini-B/M, 5P, BLACK INSULATOR SOLDER TYPE, NICKEL PLATED SHELL
4.	PVC MOLDED HOUSING, BLACK COLOR

Jargy part no.	Client part no.	Approved	SCALE	UNIT
CBL-HFD203MB-Xm			1 : 1	mm
Drawing Name		Drawn	Date	REV.
USB 2.0 A to Mini-B Cable M/M		<i>Kevin Asu</i>	2015/09/04	1.0

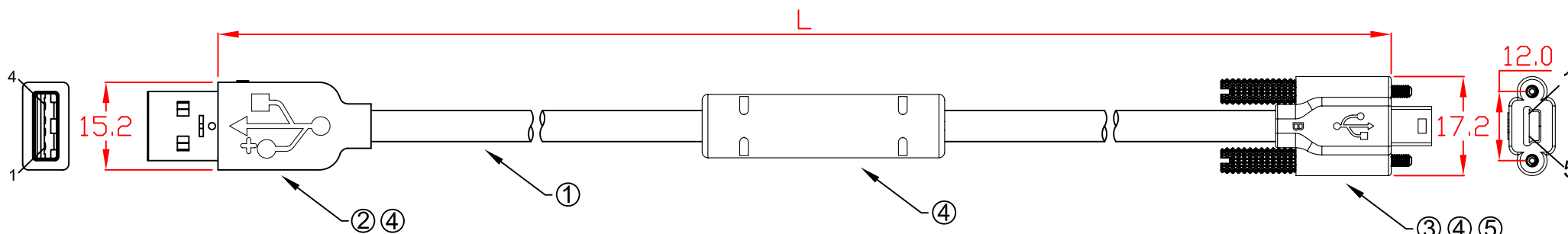
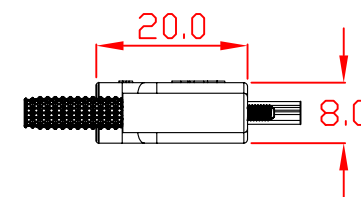
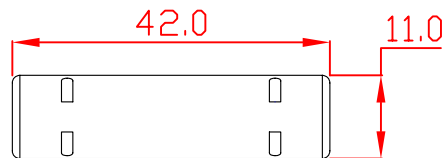
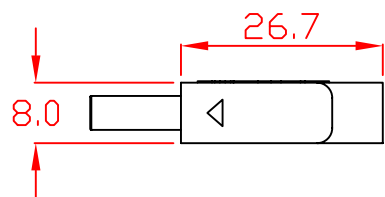

L:
 CBL-HFD203MBS-15m 15000mm±50mm
 CBL-HFD203MBS-20m 20000mm±50mm

No	MATERIALS LIST:
1.	CABLE:UL2725 (26AWG*1PR+D+AM)x2C+24AWG*2C+AM+B OD:5.4mm PVC JACKET COLOR:BLACK
2.	CONNECTOR:USB 2.0 A/M, 4P, WHITE INSULATOR SOLDER TYPE, NICKEL PLATED SHELL
3.	CONNECTOR:USB 2.0 Mini-B/M, 5P, BLACK INSULATOR SOLDER TYPE, NICKEL PLATED SHELL
4.	PVC MOLDED HOUSING, BLACK COLOR
5.	SCREW:#4x33 M2

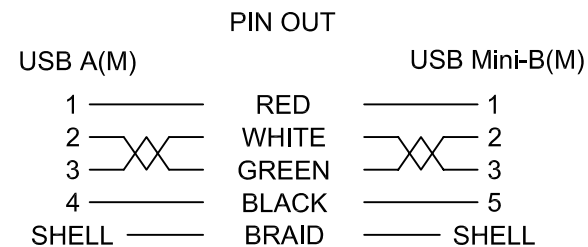

Jargy part no.	Client part no.	Approved	SCALE	UNIT
CBL-HFD203MBS-Xm			1 : 1	mm
Drawing Name		Drawn	Date	REV.
USB 2.0 A to Mini-B Cable M/M		<i>Kevin Asu</i>	2015/09/04	1.0

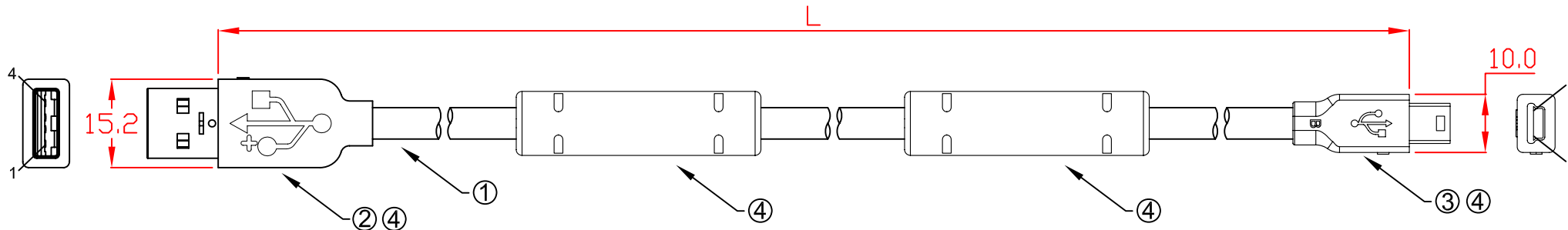
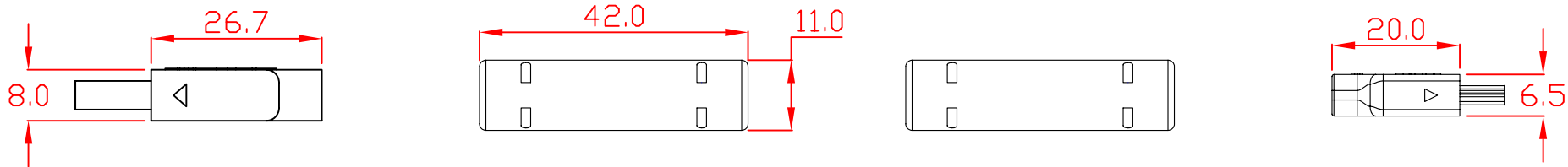

L:
 CBL-HFD203MB-25m 25000mm±50mm
 CBL-HFD203MB-30m 30000mm±50mm

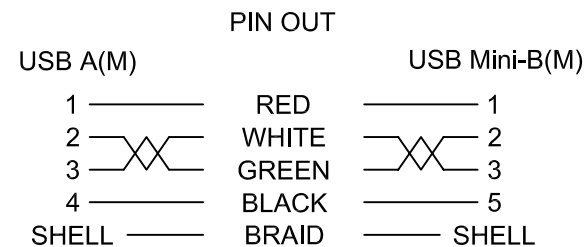

No	MATERIALS LIST:
1.	CABLE:UL2725 (26AWG*1PR+D+AM)x2C+24AWG*2C+AM+B OD:5.4mm PVC JACKET COLOR:BLACK
2.	CONNECTOR:USB 2.0 A/M, 4P, WHITE INSULATOR SOLDER TYPE, NICKEL PLATED SHELL
3.	CONNECTOR:USB 2.0 Mini-B/M, 5P, BLACK INSULATOR SOLDER TYPE, NICKEL PLATED SHELL
4.	PVC MOLDED HOUSING, BLACK COLOR

Jargy part no.	Client part no.	Approved	SCALE	UNIT
CBL-HFD203MB-Xm			1 : 1	mm
Drawing Name		Drawn	Date	REV.
USB 2.0 A to Mini-B Cable M/M		<i>Kevin Asu</i>	2015/09/04	1.0

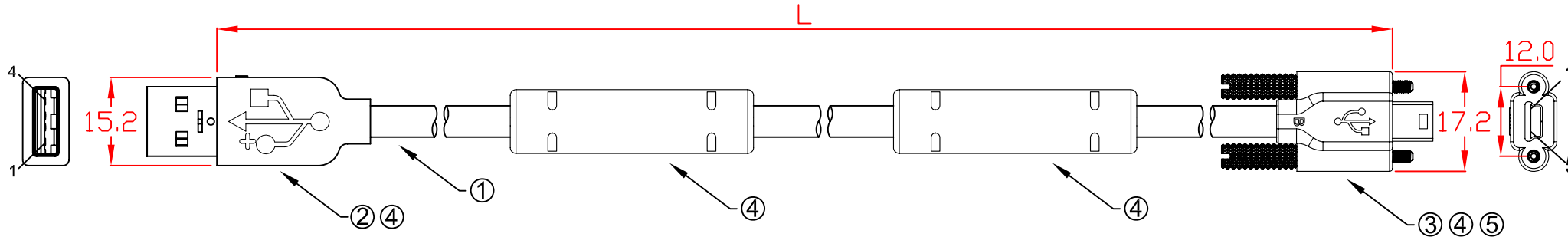
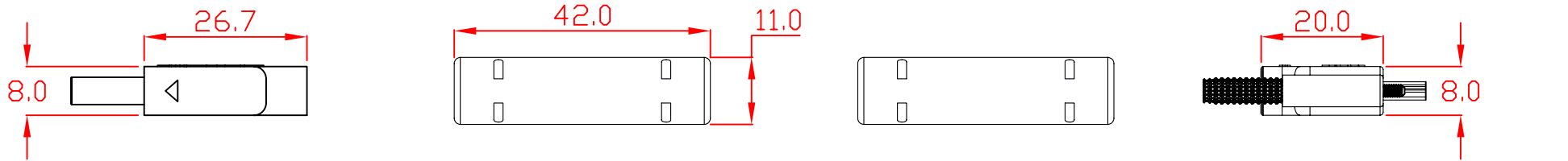

L:
 CBL-HFD203MBS-25m 25000mm±50mm
 CBL-HFD203MBS-30m 30000mm±50mm

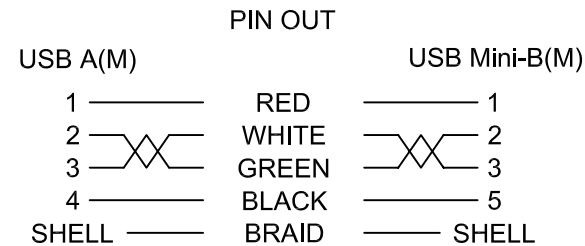

No	MATERIALS LIST:
1.	CABLE:UL2725 (26AWG*1PR+D+AM)x2C+24AWG*2C+AM+B OD:5.4mm PVC JACKET COLOR:BLACK
2.	CONNECTOR:USB 2.0 A/M, 4P, WHITE INSULATOR SOLDER TYPE, NICKEL PLATED SHELL
3.	CONNECTOR:USB 2.0 Mini-B/M, 5P, BLACK INSULATOR SOLDER TYPE, NICKEL PLATED SHELL
4.	PVC MOLDED HOUSING, BLACK COLOR
5.	SCREW:#4x33 M2

Jargy part no.	Client part no.	Approved	SCALE	UNIT
CBL-HFD203MBS-Xm			1 : 1	mm
Drawing Name		Drawn	Date	REV.
USB 2.0 A to Mini-B Cable M/M		<i>Kevin Asu</i>	2015/09/04	1.0

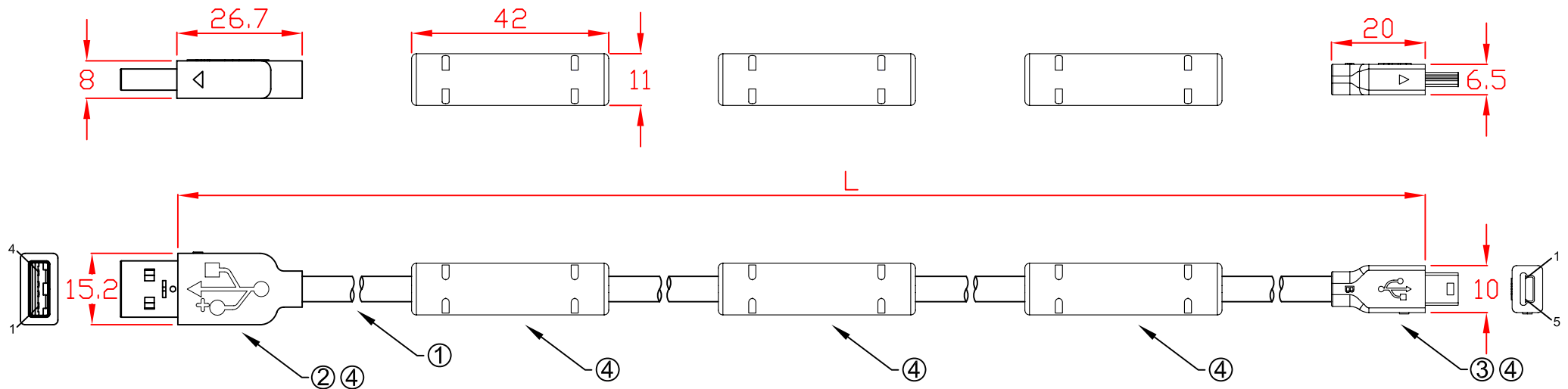

L:
 CBL-HFD203MB-35m 35000mm±50mm
 CBL-HFD203MB-40m 40000mm±50mm

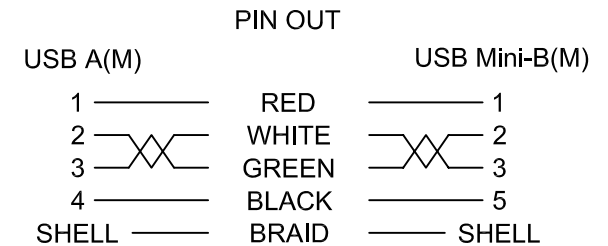

No	MATERIALS LIST:
1.	CABLE:UL2725 (26AWG*1PR+D+AM)x2C+24AWG*2C+AM+B OD:5.4mm PVC JACKET COLOR:BLACK
2.	CONNECTOR:USB 2.0 A/M, 4P, WHITE INSULATOR SOLDER TYPE, NICKEL PLATED SHELL
3.	CONNECTOR:USB 2.0 Mini-B/M, 5P, BLACK INSULATOR SOLDER TYPE, NICKEL PLATED SHELL
4.	PVC MOLDED HOUSING, BLACK COLOR

Jargy part no.	Client part no.	Approved	SCALE	UNIT
CBL-HFD203MB-Xm			1 : 1	mm
Drawing Name		Drawn	Date	REV.
USB 2.0 A to Mini-B Cable M/M		<i>Kevin Asu</i>	2015/09/04	1.0

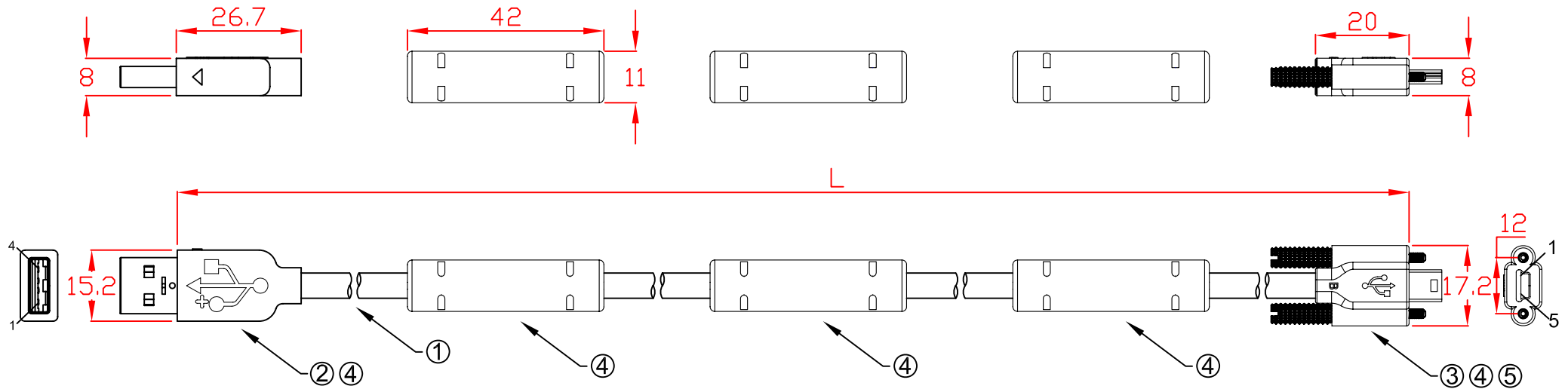

L:
 CBL-HFD203MBS-35m 35000mm±50mm
 CBL-HFD203MBS-40m 40000mm±50mm

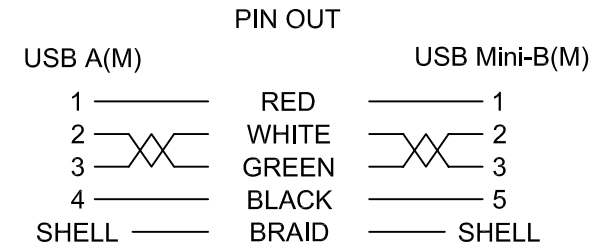

No	MATERIALS LIST:
1.	CABLE:UL2725 (26AWG*1PR+D+AM)x2C+24AWG*2C+AM+B OD:5.4mm PVC JACKET COLOR:BLACK
2.	CONNECTOR:USB 2.0 A/M, 4P, WHITE INSULATOR SOLDER TYPE, NICKEL PLATED SHELL
3.	CONNECTOR:USB 2.0 Mini-B/M, 5P, BLACK INSULATOR SOLDER TYPE, NICKEL PLATED SHELL
4.	PVC MOLDED HOUSING, BLACK COLOR
5.	SCREW:#4x33 M2

Jargy part no.	Client part no.	Approved	SCALE	UNIT
CBL-HFD203MBS-Xm			1 : 1	mm
Drawing Name		Drawn	Date	REV.
USB 2.0 A to Mini-B Cable M/M		<i>Kevin Asu</i>	2015/09/04	1.0

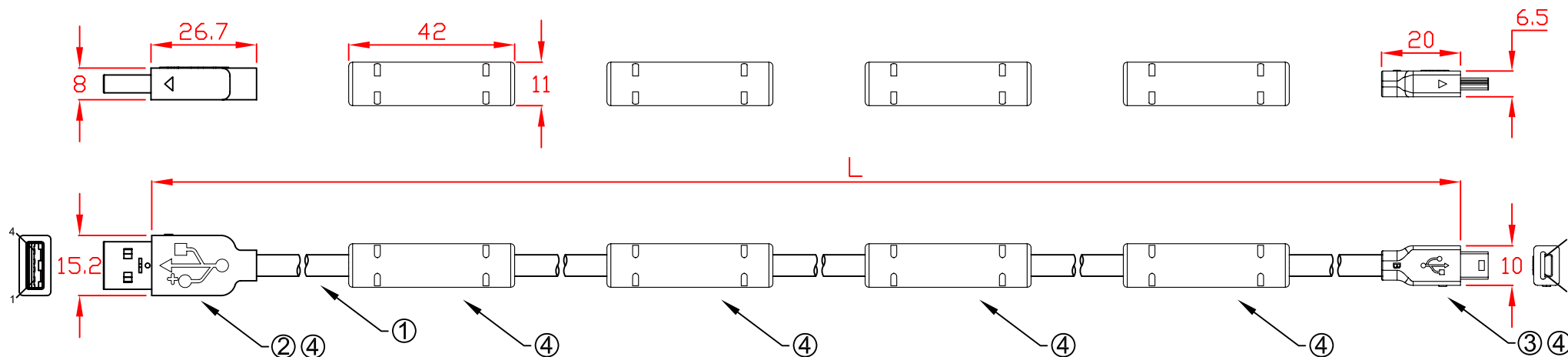

L:
 CBL-HFD203MB-45m 45000mm±50mm
 CBL-HFD203MB-50m 50000mm±50mm

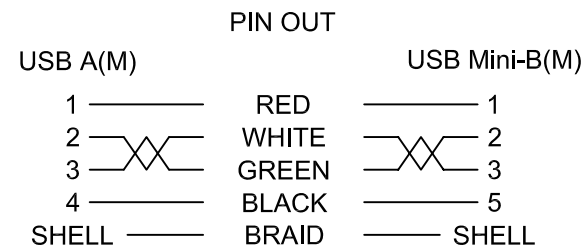

No	MATERIALS LIST:
1.	CABLE:UL2725 (26AWG*1PR+D+AM)x2C+24AWG*2C+AM+B OD:5.4mm PVC JACKET COLOR:BLACK
2.	CONNECTOR:USB 2.0 A/M, 4P, WHITE INSULATOR SOLDER TYPE, NICKEL PLATED SHELL
3.	CONNECTOR:USB 2.0 Mini-B/M, 5P, BLACK INSULATOR SOLDER TYPE, NICKEL PLATED SHELL
4.	PVC MOLDED HOUSING, BLACK COLOR

Jargy part no.	Client part no.	Approved	SCALE	UNIT
CBL-HFD203MB-Xm			1 : 1	mm
Drawing Name		Drawn	Date	REV.
USB 2.0 A to Mini-B Cable M/M		<i>Kevin Hsu</i>	2015/09/04	1.0

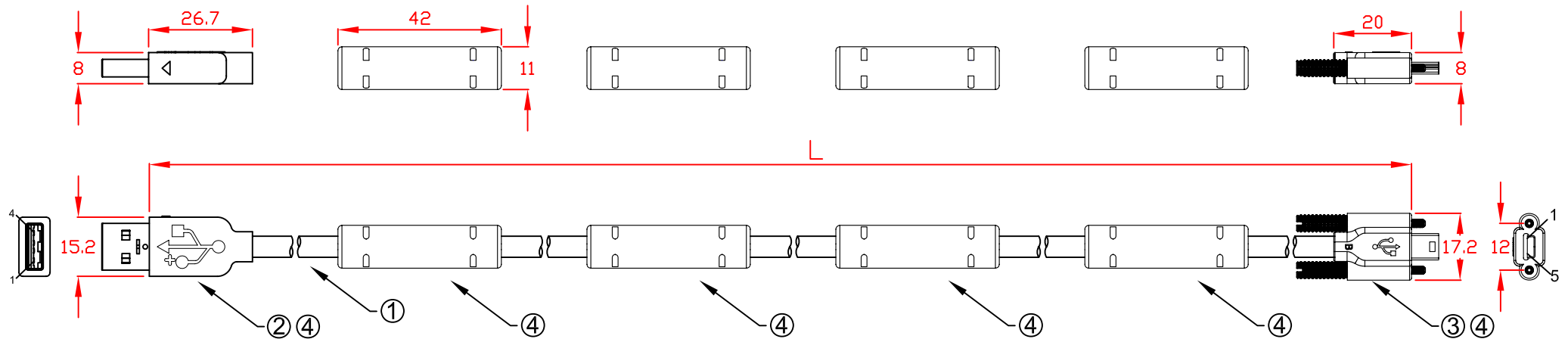

L:
 CBL-HFD203MBS-45m 45000mm±50mm
 CBL-HFD203MBS-50m 50000mm±50mm

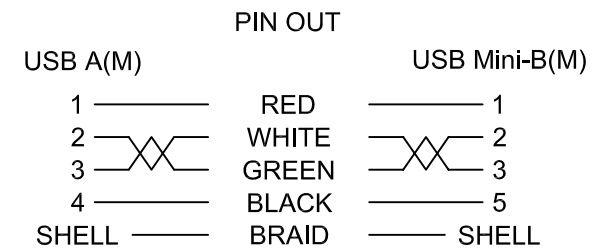

No	MATERIALS LIST:
1.	CABLE:UL2725 (26AWG*1PR+D+AM)x2C+24AWG*2C+AM+B OD:5.4mm PVC JACKET COLOR:BLACK
2.	CONNECTOR:USB 2.0 A/M, 4P, WHITE INSULATOR SOLDER TYPE, NICKEL PLATED SHELL
3.	CONNECTOR:USB 2.0 Mini-B/M, 5P, BLACK INSULATOR SOLDER TYPE, NICKEL PLATED SHELL
4.	PVC MOLDED HOUSING, BLACK COLOR
5.	SCREW:#4x33 M2

Jargy part no.	Client part no.	Approved	SCALE	UNIT
CBL-HFD203MBS-Xm			1 : 1	mm
Drawing Name		Drawn	Date	REV.
USB 2.0 A to Mini-B Cable M/M		<i>Kevin Asu</i>	2015/09/04	1.0